

CHRONOTAR

CHRONOGRAPH

MANUAL

CE-2

V-1.04

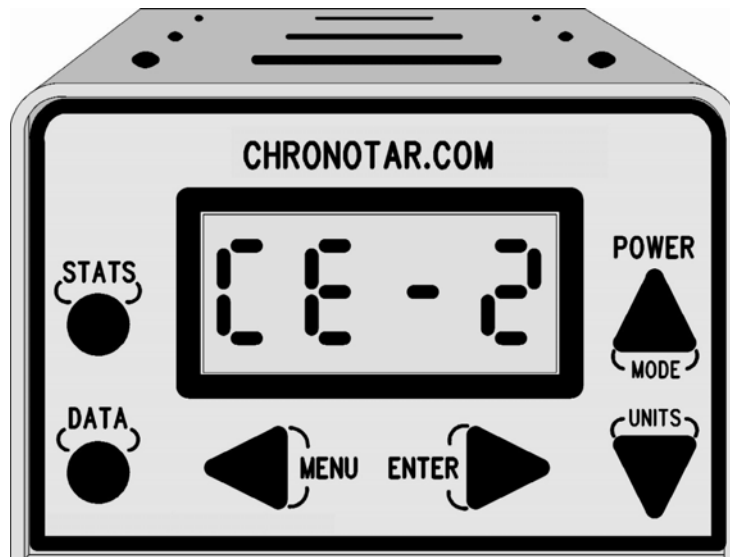

Quick Reference is on page 6

This and other manuals are posted on

<http://www.chronotar.com>

©Copyright Chronotar Micro, 2002, 2003

This product is sold by

<http://www.chronotar.com>

Warning

Before you use this product you must follow all safety instructions as recommended by manufacturer of your firing device, no matter what that device may be. Irrespective of who the manufacturer of your firing device may be, you alone are ultimately responsible for using correct safety precautions. You should not use this product to get combustion pressure for your firearm.

Liabilities

This product is a passive optical instrument. It does not emit any radiation in order to measure projectile velocities.

It is your sole responsibility to safeguard yourself and other people against any injury or property damage when firing projectiles near the unit or accidentally into the unit. You must not use this product to determine firearm combustion pressure.

This product relies heavily on complex hardware, software and operating system. Because of its complexity, a finite probability exists that a software module or a hardware component may fail to function properly. This failure may result in a loss or change of data which could produce erroneous velocity measurement. For example, a simple LCD-element failure may display number 8 as number 9 or 6. There are thousands of possible failure modes; therefore this product is not a fail-save product. If fail-save velocity measurements are required, then this product must not be used without our written approval. Approval requests will be considered only if setup is based on "multi-chronograph-majority-vote design" and it must be accompanied by failure analysis.

We assume no responsibility for the injury to any person or persons whether be consequential or inconsequential as a result of using this product. We also assume no responsibility for the damage to any property or loss of profit as a result of using this product.

This product and all its associated hardware and software design are ©Copyright property of Chronotar Micro.

If you do not agree with any of the above statements then you must not use this product. Instead, you must return it immediately and intact, to the place of purchase for a full refund.

Table of contents

QUICK REFERENCE	6
Adaptive Calibration	6
One Key functions	6
Two-key functions	6
Three-key functions	7
USA and Metric display identifiers	7
Archery mode control	7
Muzzle blast control	7
Errors and alarms	8
Battery Alarms	8
Chronograph Alarms	8
Operator Errors	9
Memory Overflow Errors	9
Displayed value has no decimal point	9
Calibration Status Results	10
Indoors Setup	11
Outdoors Setup	11
QUICK START	12
Turning the unit on, first time	13
Verify Operation	13
QUICK SETUP	15
Indoors Setup	15
Outdoors Setup	16
LED Array	17
RUN CALIBRATION	18
<i>Indoors Calibration results</i>	19
<i>Outdoor Calibration results</i>	19
Marginal calibration results	21
Muzzle Blast	22
High readings	23
GETTING STARTED	24
First Time User	25
How the chronograph works	25
Light source required	26
Fluorescent lights	26
Incandescent lights	26
Light Diffusers	27
KEY FUNCTIONS	28
<DATA> Data Mode	29
<STATS> Stats Mode	30
Statistics List	30
Percent Standard Deviation (PSD)	31

<MENU> Model number & Menu	33
<ENTER> Lower digits view	33
Extended Digits	33
<UNITS> USA-Metric Conversion	34
<POWER> Turn unit On-Off	35
EXTENDED KEY FUNCTIONS	36
Delete shot <MENU+DATA>	36
Clear memory <MENU+STATS >	36
Sensors Off <MENU+POWER>	37
Switch to CF mode <MENU+UNITS>	37
Battery power level <ENTER+POWER>	38
Muzzle Blast Control <ENTER+UNITS>	38
Find Stats-Shot <DATA+STATS>	39
Increment String <ENTER+STATS>	40
Cross String Stats <STATS+ENTER>	40
Undo Cleared Memory <MENU+ENTER+STATS>	41
Data Recovery <MENU+ENTER+POWER>	41
Archery On-Off <ENTER+POWER+UNITS>	42
Reboot the unit <UNITS+MENU+DATA >	43
Memory Alarms MENU+ENTER+UNITS+STATS>	43
Access Control <MENU+ENTER+UNITS+DATA>	43
POWER-UP FEATURES	44
ARCHERY MODE NOTES	45
Supersonic Firearms	45
Indoors & Interference	45
High Detection Capability	46
Our Archery vs Theirs	46
ERROR MESSAGES	46
Calibration Failure	47
Setup Failure	47
Battery	47
Velocity Capture	48
Memory Overflow	48
Operator	49
TROUBLESHOOTING	50
<i>Dead Unit</i>	50
<i>Flashing Decimal Point</i>	50
<i>Flashing Colon</i>	51
<i>Unit will not Calibrate</i>	51
SPECIFICATIONS	54
WARRANTY	54
INDEX	55

Important Notes

Muzzle blast & noise control

User set muzzle blast & noise control provides reduction range settings from **00%** to **98%**. Unfortunately high muzzle blast reduction settings also reduce sensitivity. It is better to move the unit farther back rather than using muzzle blast control. For archery, paintball and all quiet devices use **00%**.

Turning off sensors and alarms

Special function has been provided that turns off detection electronics to save battery power and stop environment alarms. The key sequence to do this is,

<MENU+POWER>

This function is used only when data and statistics review are needed. To activate velocity measurement again you **must** turn the unit **Off** and **On** again. Do not **forget it**, because the unit will **stop** accepting shots. To check if sensors are turned off press **<MENU>** key; this activates pending alarms again.

Change Battery without losing data

First you turn the unit **Off**. While the unit is **Off** you must **not touch** any of the **keys**. The system software will stay alive, in hibernation, without battery for up to **8 minutes** (max 20). You have about 8 minutes to replace the **old** battery with a **new** one. If the battery is installed **backwards** then memory-data may be lost.

Flashing colon or flashing decimal points

Flashing colon or decimal points indicate that the unit will **no longer accept shots** because environment conditions have changed. You can either turn sensors off and use the unit for data review only, or you can calibrate it again. Please note that the unit will not accept shots unless it is calibrated again.

Splash stickers

Some units, CE-1A and CE-2A , will accept transparent stickers, that are placed over the optical slots to **protect** against **black powder** and **paintball** debris. When you clean these do not scratch the surface because it will effect velocity measurements. These stickers must be replaced if scratched.

Quick Reference

Adaptive Calibration

This unit **must be calibrated** before you start your shooting session, light conditions have changed, or it was relocated. Calibration is done by turning the unit **Off** and then **On** with **<POWER>** key. Calibration is over when flashing **[CAL.]** is displayed. If a **decimal point** or **colon** appears, it indicates that calibration failed (see "**Run Calibration**"). When Adaptive Calibration is finished you must **acknowledge** it by pressing **<ENTER>** key or else the unit **will not work** it will simply flash calibration results **forever**. For example: alternate flashing of **[S.L.]** and **[CAL.]** indicates fluorescent lights are overhead. If environment is **unstable** for a period of **60** seconds, or any **key is pressed** while calibration is active, then all calibration **alarms** are turned **on**. You must try to calibrate again, fix environment problem or relocate the unit.

One Key functions

<POWER> Turns the unit on or off, unconditionally
<UNITS> Flips between meters and feet on the fly
<ENTER> Displays the least significant digits
<MENU> Displays model number, in CF Mode selects menu
<STATS> Sets Stats Mode and reviews statistics
<DATA> Sets Data Mode and reviews shots stored in memory

Two-key functions

This requires that you press two keys in sequence as shown in the table below. For example; **<MENU+DATA>** requires that you press and hold down **<MENU>** key, while you hold down **<MENU>** key press **<DATA>** key. To end this function you must release both keys at the same time.

<MENU+DATA> Deletes current shot number
<MENU+STATS> Clears memory string
<MENU+POWER> Turns sensors off
<MENU+UNITS> Flips between **CE** and **CF** mode
<ENTER+POWER> Displays battery power level in % Power
<ENTER+UNITS> Sets Muzzle blast control value
<DATA+STATS > Finds shot position of the current Stats







Three-key functions

This requires that you press three keys in sequence as shown in the table below. For example: **<MENU+ENTER+DATA>** requires that you press and hold down **<MENU>** then **<ENTER>** and finally **<DATA>** key. To end this function you release all the keys at the same time.

<MENU+ENTER+DATA>	Undo “delete shot”
<MENU+ENTER+STATS>	Undo “clear memory”
<MENU+ENTER+POWER>	Recover all data from trash
<ENTER+POWER+STATS>	Muzzle blast control-2, advanced
<ENTER+POWER+UNITS>	Flip archery mode On or Off
<ENTER+POWER+DATA>	Load demo shots
<UNITS+MENU+DATA>	Reset the unit



USA and Metric display identifiers

When **<UNITS>** key is pressed display will identify units used.

	Indicates Metric units are selected, meters/sec
	Indicates USA units are selected, feet/sec
	Two dots on each side of 08 indicate Metric velocity
	Two dots on each side of Lo indicate Metric Stats
	Absence of dots indicates USA units for velocity
	Absence of dots indicates USA units for Stats

Archery mode control



When archery mode is changed, display will identify current mode. The keys to do this are **<ENTER+POWER+UNITS>**.

	Archery mode is turned off.
	Archery mode is turned on.

Muzzle blast control

When muzzle blast control value is changed, the display will identify current value. Available range is from **00%** to **98%**.

The keys to do this are **<ENTER+UNITS>**.

	Example of muzzle blast & noise reduction of 30%
	Example of muzzle blast & noise reduction of 00%

Errors and alarms



Alarms are displayed as a flashing message. The message will flash for 10 seconds and then disappear. Pressing **<ENTER>** key makes the alarm disappear. The **CF** mode has advanced alarm control settings, see CF Manual.

Flashing **dots** and flashing **colon** are special alarms that do not go away they indicate bad light conditions. These go away only if you fix the problem or turn sensors off, see **”Turn Sensors Off”**.

- Flashing **colon**: sensors are off, unit will not accept shots
- Flashing **decimal points**: calibration failed, bad conditions
- Flashing **decimal points**: and/or **colon** requires recalibration
- Flashing **last digit**: displayed number is greater than **9999.99**, you must press **<ENTER>** key to see the rest of the number.







Battery Alarms

Battery alarms only come on once and it happens when battery voltage goes below alarm value. After it has been acknowledged, or it times out, it no longer comes on until conditions change or reminder timer, 60-sec interval, activates it again.

	Battery is dead, only data and stats review possible
	Battery power level is too low for detecting velocities
	Battery power level is low, performance will degrade

Chronograph Alarms

Chronograph alarms always time out. These alarms may be turned by **Off** by sensors off function, see **”Turn Sensors Off”**.

	Front sensor was missed
	Middle sensor was missed
	Rear sensor was missed
	Possible muzzle blast
	EMI or other Interference, must recalibrate
	
	

Operator Errors

Operator errors come on when an illegal function is attempted. This is due to access violation, improper use of functions etc.

Err 1	Undelete shot not possible, trash bin empty or lost
Err 2	Memory is not empty, cannot load test shots
Err 3	Access denied, you do not have access privileges
Err 8	General access violation

Memory Overflow Errors

When the string is almost full, a warning alarm comes on. This is user option that must be set within **CF** mode first. **CE** default at start-up is a simple interface with these alarms disabled. The unit tracks data history and only the oldest shots are overwritten first.

Err 0	Memory is full, there is no more room. If you fire any more shots then the oldest one will be lost.
Err 1	You have room for one last shot in this string

Displayed value has no decimal point

If there is no decimal point showing, even when **<ENTER>** key is pressed, then this implies that the decimal point is after the fourth digit. For example; numbers **1000.00** to **9999.99** and **1000.000** to **9999.999** will have no decimal point displayed.

CF Series mode

CF Mode is an advanced mode that provides full control over data manipulation and environment settings. This mode uses scroll keys and menus, a far better system than multi-key operations. This mode is selected with **<MENU+UNITS>** key and it provides over 50 functions. **CF-Mode** has access to multiple strings, cross string statistics, power factor, energy and more. CF Manual is not ready yet for publication only a draft copy will be available on our website after Aug/2003. We strongly recommend that you download and read CF Manual before using this mode. This mode is provided as an experimental added bonus. **If you get stuck in CF Mode**, press **<UNITS+MENU+DATA>** to reset the unit; this unconditionally returns to **CE-Mode**.

Statistics List

Statistics needs more than one shot it does not need a full string.

.Lo.	Low	The lowest value found
.Hi.	High	The highest value found
.Av.	Average	Average value
.ES.	Extreme Spread	Highest value minus lowest
.Sd.	Standard Deviation	Uses population (n-1)
.Pd.	Percent STD	Percent standard deviation (n-1)
.fo.	Total shots	Total shots in the current string
.PF.	Power Factor	Power factor, CF-Mode only
.EN.	Energy	Energy, CF-Mode only

Calibration Status Results

Calibration status number is indicated by the flashing display that follows calibration completion. For example, if calibration status number was **+135** then the display will flash between **CAL :** and **135**.

Indoors calibration status numbers

- (-450 to -511) fluorescent light overhead, or strong EMI.
- (-001 to -400) fluorescent and incandescent lights mixed.
- (+001 to + 350) functional range.
- (+400 to +511) too dark, must provide some light.

Outdoors calibration status numbers

- (-300 to -511) man-made interference nearby.
- (-001 to -250) EMI or bright sun, try using diffusers.
- (+001 to +350) functional range.
- (+400 to +511) too dark, diffusers might help.

Marginal calibration status results

- (+400 to +500) indicates marginal conditions, needs light
- (-001 to -511) indicates bad conditions, must fix problem.

Indoors Setup

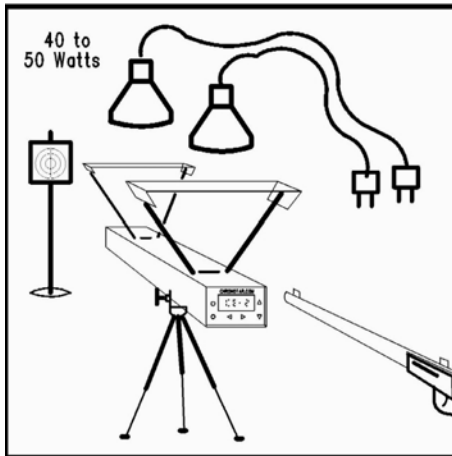

Install diffusers as shown and two 40 to 60 Watt light bulbs about 2 to 4 feet from the diffusers. You can also use single 100-Watt floodlight 4-feet above the center of unit. If you have a white ceiling, use two 150-Watt flood lights pointing up into the ceiling. The ceiling should not be more than 10-feet high. Avoid using solid state dimmers, see "**Indoors Setup**". When finished with

setup do not **forget** to run **calibration** by turning the unit **Off** and **On**. Avoid using **archery** mode indoors, see "**Archery Mode**"

Outdoors Setup

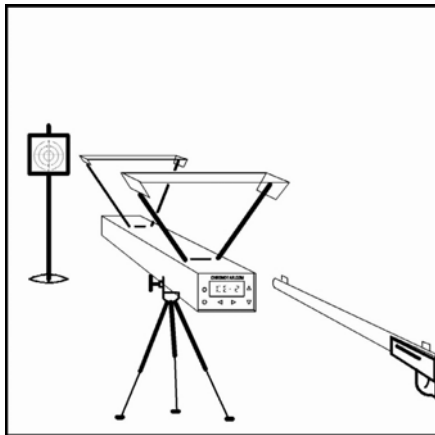

With Diffusers

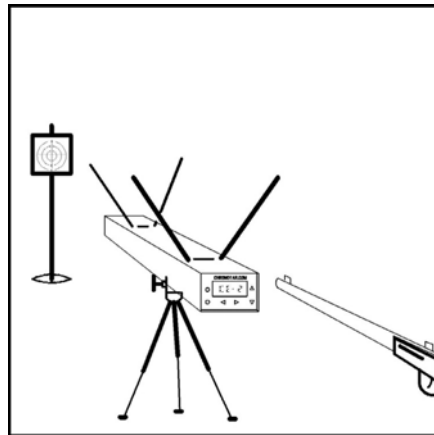

Without Diffusers

After setup is completed, **run calibration** to determine if diffusers are required. Only adaptive calibration will confirm if you need **diffusers**, because light conditions can be deceiving to the naked eye. If calibration number is not between **-300** and **+450** then you must use diffusers. For further details see "**Outdoors Setup**".

Before you use archery mode please see "**Archery Mode Notes**" first. Our units, even in normal mode, outperform competing units that have specially modified hardware for archery.

Quick start

If you have never used an optical chronograph, or you are not familiar with such a device, then we recommend that you read "**Getting Started**" section first.

This device is an optical instrument, therefore dust and dirt will affect its operation. We strongly recommend that you treat it with the same respect as you would a digital camera.

Unpack the unit and install a new 9-Volt battery

Note

Battery voltage must not exceed **10** Volts at any time, because this may **destroy** the unit.

If the unit does not start, remove the battery and press and hold down **<POWER>** key while you count from **1** to **30**. Release the key then install the battery again. If this does not work then **check battery voltage**. See "**Troubleshooting**"... "**Dead unit**"

The unit will detect shots **properly** only if the battery voltage is **above 7-Volts**. If the battery is less than **7-Volts** it should **only be used** for Data/Stats retrieval-review even if it still detects shots.

Most chronographs appear dead if the battery voltage drops below **6.5-Volts**. Our unit still functions even when the voltage drops below **4.6** volts.

Please note: when battery power alarms comes on it is necessary to replace the battery because the unit will no longer detect shots as intended.

Battery power alarms:   

Turning the unit on, first time

After battery is installed, the unit goes through a self test. This also happens when **<DATA+MENU+UNITS>** keys are pressed, which reboots the unit. The test is only performed once and it is not done when the unit is turned off and on using **<POWER>** key. It takes approximately 12 seconds to complete this test. During this time all the elements of LCD are displayed as follows,

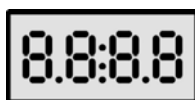

These elements are then cleared one by one, until LCD is blank as shown below,



This is done slow enough so as to allow the eye to observe and inspect each element as it is cleared. There are other internal tests but are not noticeable. If any key is pressed during the LCD tests, then LCD test is aborted immediately.

When the unit is ready for the first time, it will display the model number. For example **CE-2** will be displayed as follows,

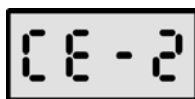

Verify Operation

After all the tests are done, a quick internal calibration makes the unit ready for shooting. If the light conditions are not right then the unit may give one of the following flashing error messages, **[Err1]**, **[Err2]**, **[Err3]**, **[Err4]**, **[Err7]**, **[Err8]** or **[Err9]**.

These errors generally appear if the calibration command has not been executed yet and the light conditions are bad. For now these messages can be ignored.

There is another set of error messages that may appear, the list is as follows, **[Prr1]**, **[Prr2]**, **[Prr3]**. These alarms are very **serious** and cannot be **ignored**. They indicate battery voltage status and have the following meaning,

- [Prr1]** Battery is dead
- [Prr2]** Battery is too low for normal operation
- [Prr3]** Battery is low, performance will degrade

For further details see **"Alarms & Errors"..."Battery"**.

If the unit has previously been used and it still has a battery in it, then you just press **<POWER>** key to awake up the unit. If the unit does not wake up see **"Troubleshooting"..."Dead Unit"**.

It is easier to check the unit before it is set up. It is also a good practice to check battery power level before you start shooting session. The battery level is checked with **<ENTER+POWER>** keys. The value is displayed only while you hold down both keys. The number displayed represents percent of power left. The battery should have more than **34%**, in order for you to proceed. At **34%** percent the battery has dropped below 7.0 volts.

For example if the battery power level was **43%** percent, then the display will show **[43]**.

There is nothing to stop you from running on a low battery as long as you keep in mind that at **34%** the **"Battery Alarms"** begin to appear and performance will degrade.

Quick setup

You are now ready to set up the unit; chose any of the setting below that matches your needs. If you do not have a tripod then you can use any surface, table, stool etc. The only requirement is that the unit be aligned with your shooting sight. Whatever you do, do not shoot the unit because it will be destroyed. You have to shoot 4 to 12 inches above the unit. Use the black rods as a guide. Loud firearms generate a muzzle blast which may cause problem, see "**Muzzle Blast**".

The best results are obtained with "**LED Array Setup**", Second best is "**Outdoor Setup**". Indoor setup works best for high speed bullets or anything that is faster then 25 feet/sec unless infrared lights are used.

Indoors Setup

If you are not using our solid state light fixture "**LED Array**". then you must set up the unit as shown on this picture.

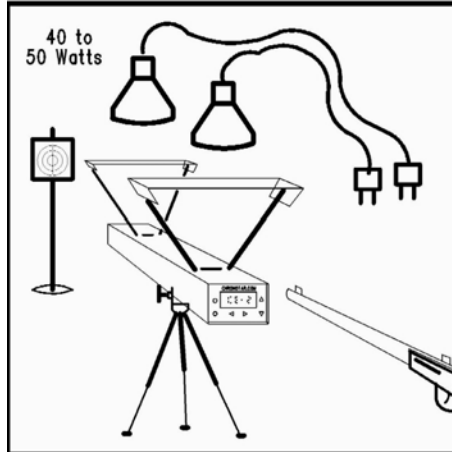

Install diffusers as shown and two 40 to 60 Watts light bulbs about 2 to 4 feet high from the diffusers. If you use flood lights, then a single 100-Watt bulb, 4-feet above the center of unit would be sufficient. Infrared lights are the best. If you have a white ceiling then use two 150-Watts flood lights pointing up into the ceiling, above each optical slot. The ceiling should not be over 10-feet high. The whiter

the ceiling the higher it may be. When using this method, diffusers are not required.

Avoid using solid state dimmers because they generate a lot of **EMI** that may cause problems. Adaptive Calibration will reduce sensitivity level when EM radiation is detected from these dimmers.

Outdoors Setup

For outdoors you do not always need diffusers. If they obstruct your view and you prefer not to use them, then you must run calibration function to determine whether you need them or not. This is described in "**Run Calibration**".

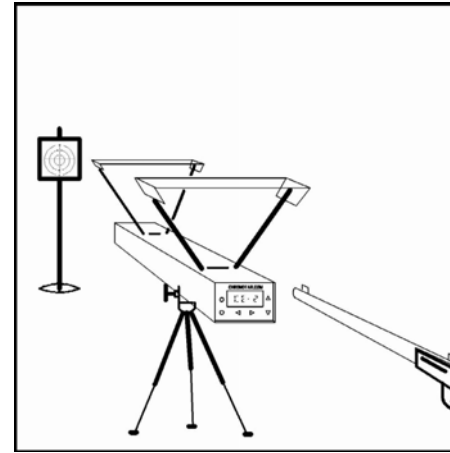

With Diffusers

Set up the unit as shown on this picture. You normally do not need diffusers, however you should use them if possible. They provide a uniform source of light for accurate measurement. On a darker day or when the sky is very deep blue, diffusers have the ability to collect light from surrounding area.

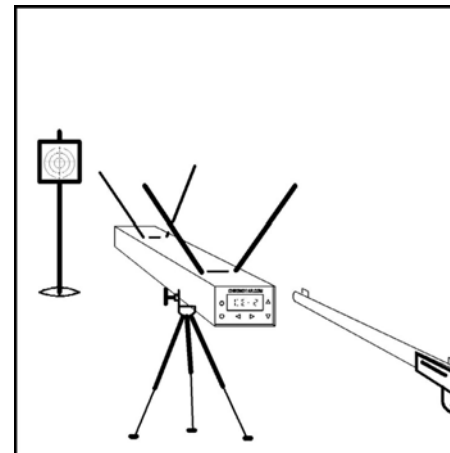

Without Diffusers

If the sky is overcast and it looks milky white, you do not need diffusers. However you must verify that the unit will function without diffusers. To verify this please read "**Run Calibration**" section below. Calibration results must be between -001 and +400 for the unit o function well without diffusers.

LED Array

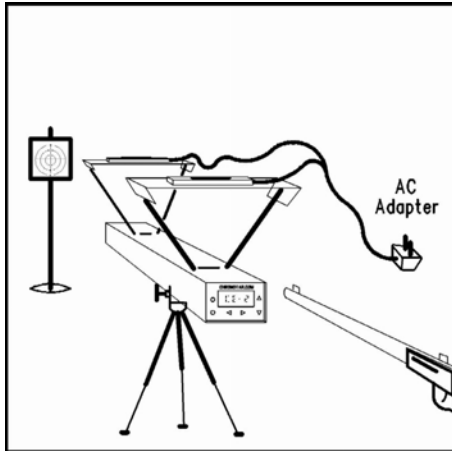

Install the two LED Arrays as shown on this picture, one over each optical slot and plug in the AC Adapter.

This is a solid state light source that produces high quality monochromatic light. It uses high intensity LED's. It can be used anywhere, indoors or outdoors, in a bright or a dark place.

Run Calibration

After the unit has been set up, you are ready to test the light conditions. If the unit is on, then turn it **Off** and **On** again by pressing **<POWER>** key. The unit will now go through adaptive calibration, and display will show rapidly moving number. This number represents calibration status. It can go from **-511** to **+511** and it may take as long as **60** seconds to complete.

This is not an ordinary chronograph but the first generation of smart chronographs. Adaptive calibration scans for a broad range of light conditions and interference sources to calculate optimum setup. The calibration process and setup is rather complex and is beyond the scope of this manual.

Typical sources of interference that the unit will track are: fluorescent lights, flickering bulbs, sodium lamps, airborne sand drifts, airborne snow drift, flock of birds, strong RF signals, AC power lines and any EMI source.

If the light conditions are good and there are no sources of interference, the scan is completed in less than **30** seconds.

When a significant interference or bad light condition is detected, then the unit needs time to calculate and verify the effect it may have on velocity measurements. Depending on the type of condition, it could take up to **60** seconds to complete the job. When conditions are bad then all 3 decimal points on the LCD start to flash.

If you press any key before calibration is finished then the calibration is immediately terminated and **Calibration Failure** alarm is turned on. To remedy this you must press **<ENTER>** key once to acknowledge the error and then recalibrate again by turning the unit **Off** and **On** again.

When calibration scan is completed and setup is acceptable for normal operation, the display will flash between a final calibration **status-number** and calibration-command **[CAL:]**.

For example, if calibration status was **+135** then the display will flash between **[135]** and **[CAL:]**. If there are no flashing decimal points then the operation was successful.

The flashing number represents the quality of your light conditions as well as the type of interference found and how severe it is. Here are typical results for indoors and outdoors,

Indoors Calibration results	
Number Range	Explanations
-400 to -511	Fluorescent lights are overhead or incandescent lights are too strong.
-001 to -350	Fluorescent & Incandescent lights mixed or strong EMI.
+001 to +350	Very good condition.
+360 to + 400	Incandescent light are too far or the light bulb power is it to low.
+400 to +511	Too dark, there is not enough light available. You must provide some light or try diffusers.

Outdoor Calibration results	
Number Range	Explanations
-300 to -511	RF Interference, Power lines, EMI or sodium lamps nearby.
-001 to -150	Direct sunlight is shining into the optical slots. Must change angle or use diffusers.
+001 to 350	Very good condition.
+360 to + 400	Dark or blues skies. Must use diffusers.
+400 to +511	Too dark or very deep blue skies. Diffusers might help.
Any number with flashing dots	This is a general failure indicator with possibility of power lines or powerful radio transmitters nearby.

If a serious problem has been encountered, then **three dots** will be flashing very fast indicating **calibration failure**.

For example, if the unit has detected fluorescent lights, then the display may flash between these two displays,



The three decimal points will flash independently and even faster.

If calibration failed you could try again a few times and if failure persists then you must remove the source of problem.

When calibration is finished you must acknowledge calibration results by pressing **<ENTER>** or any other key. If you do not acknowledge it, then the unit will flash calibration results for ever and it will not accept shots. After you press any key, a final environment tests is performed, but because it is fast it will not be noticed.

If there is anything wrong with the environment following adaptive calibration, a flashing **COLON** will appear, indicating that the unit will not function under current conditions.

The unit will however still function if the results of calibration are marginal; it is up to you to decide if you want to proceed.

Marginal calibration results

-001 to -400	Archery mode does not perform well here. Low velocities measurement will be affected. We do not recommend using archery mode here. Diffusers should be used.
+350 to +450	Accuracy and sensitivity are reduced. It will require that you shoot closer to the unit to obtain good results it could be as low as 4". Try using diffusers, it might help.
Flashing DOTS	Calibration failure has been detected. Sensors have been turned off to conserve power and the unit will not accept shots.
Flashing COLON	Conditions are changing, the unit detected a problem and it will not accept shots. Sensors are turned off to conserve power. You could try to calibrate again.

If all is well and you start measuring velocities, the following paragraphs describe how the unit will behave.

If the unit has no shots in it, when you press **<DATA>** key to place the unit in data view mode, then display will show,



It says that there are **00** shots in memory, and you are in a chronograph mode. When the key is released, it displays velocity, and since there is nothing to display it will show as follows,



These four bars will remain displayed until you fire a good shot.

When you fire the first shot, then shot number will be displayed for a period of ½ seconds. In this case it would be shot number **01** and the display will show as follows,



If your shot had a velocity of **938.54**, the display will show as follows after ½ seconds delay is over,

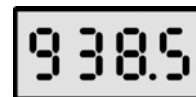

This number remains displayed until you do something else; review stats, shots or fire a new round.

To view hidden lower digits, you must press and hold **<ENTER>** key. To change the units used or check units conversion, just press **<UNITS>** key. See **"Changing Units"**.

Muzzle Blast

Muzzle blast from loud firearms can cause a false reading. This low cost unit does not detect muzzle blast 100% of the time, even with digital muzzle blast & noise control set to maximum of 98%. Therefore, to prevent false triggering, you must place the unit far back from the firearm. Here are some typical distances from the chronograph for various firearms and projectile launchers.

<u>Distance (feet)</u>	<u>Firing Device</u>
0	Archery
1	BB-Gun, Paint ball, Air rifle
3	Rim fire
4	Low caliber rifles
6	Hand guns
6	High caliber guns
8	Shot gun

If you experience false reading, you may have to move the chronograph even further from the firearm. Use digital muzzle blast control as a last recourse; see **"Muzzle Blast Control"**.

High readings

This unit will measure velocities that go beyond **10,000 f/s**. That is, we do not put restrictions on velocity measurement. Internal circuits and the software will measure any value up to **80,000.00** feet/sec. After **10,000.00** feet/sec the accuracy drops and is no longer **0.5%**. At high velocities clocking frequency becomes very important. Internal clocking frequency is **24-MHz**. If you are measuring velocities beyond **10,000.00 f/s**, e-mail us a note to ce@chronotar.com and we will provide you with more details.

WARNING

When displayed number exceeds **9999.99** then last digit on the display will flash, indicating that you ought to look at the remaining low digits. This is true irrespective of the units used. To see the low digits you simply press and hold down **<ENTER>** key.

Getting Started

CE Mode displays only the velocity measurements. Internally it stores and records temperature with each shot which is used for environment correction factor. If you need temperature values then you have to use **CF Mode**. Support for **CF Mode** is only available from our website <http://www.chronotar.com>.

If you are already familiar with chronographs you can go straight to **"Quick Start"**.

CE Mode displays the following data types,

- Velocity in
 - feet/sec
 - meters/sec
- Battery level in
 - % Power Left-

CF Mode displays the following data types,

- Velocity in
 - feet/sec
 - meters/sec
- Energy for each shot
 - Foot-Pounds
 - Meter-Newton
- Power Factor for each shot in
 - Foot/Pounds
 - Meter-Newton
- Temperature for each shot in
 - Fahrenheit
 - Celsius
- Ambient temperature in
 - Fahrenheit
 - Celsius
- Battery level in
 - % Power Left
 - Volts

First Time User

If you are using chronograph for the first time, please read the following. The chronograph is an optical instrument and should be treated as such. Excessive dust and dirt will affect accuracy and sensitivity.

How the chronograph works

Our chronograph is based on optics and it does not emit any harmful radiation, such as a radar chronograph would.

The principle of operation is very simple; two optical sensors look through the slots on top of the unit. The two sensors are located deep down in the box. When the bullet passes over the first sensors it blocks the light that shines down through the first slot.

When this happens a clock is started. When the bullet passes over the second slot, which is the rear slot, then the clock is stopped. The internal computer knows the exact spacing between the front and the rear slot therefore it can calculate the speed of the bullet using the elapsed time. The elapsed time tells the computer how long it took the bullet to travel from first slot to the last slot. This is how most of the chronographs operate.

Our chronographs have detection abilities that go far beyond ordinary chronographs; the unit has dual detection ability. It detects equally well moving shadows and moving reflections.

Also, our chronograph is the only product on the market that is able to notify you if it will work under your environment and if it needs diffusers.

The most commonly used mode is **moving shadows**. You do not need to bother setting up any of these modes because it is all automated.

The unit has 4 possible modes of operation, which are,

- **Visible light, moving shadows**
- **Visible Light, moving reflections.**
- **Infrared Light, moving shadows.**
- **Infrared Light, moving reflection.**

The unit can also function by mixing these modes during the same shot. Actually the unit selects the mode that produces the best results.

Light source required

There must be at least one of the following sources of light available for normal operation,

- **Visible light shining from the top.**
- **Visible light shining from the bottom.**
- **Infrared light shining from the top.**
- **Infrared light shining from the bottom.**

The chronograph adjusts itself to the changing light conditions. It will function from very dim light to a very bright light. When light source is from the bottom(**moving reflections**) it is desirable that it is as bright as possible.

Fluorescent lights

The chronograph does not work if fluorescent lights are above or below the unit. The unit needs a flicker-free light source, which is a steady light, such as daylight. Fluorescent lights flicker at 2x60 or 2x50 cycles per second, depending on the country of origin. Some new solid state fluorescent lights may flicker with frequencies that can exceed 10,000 cycles per second. Fluorescent light source does not have to be directly over the chronograph to cause problems. The light may bounce off the walls, ceiling etc. To prevent this light reaching chronograph sensors, you need to block it out above the sensors. Our solid state light fixture blocks any external lights, plus is generates a high quality monochromatic light source. See "**LED Array**".

Incandescent lights

A very bright incandescent light, about 60-Watts or more, shining directly into the optical slots will cause a problem. These lights do generate a very small amount of flicker that is picked up by the sensors when the intensity is very high.

Please note that we do not recommend using Archery mode with ordinary incandescent lights.

With incandescent lights you obtain the best results by using high power lamps, 100-Watts or more, reflecting off a white surface. Preferable surface would be a white paper 2 to 6 feet above the sensors. Please see "**Setting Up**"... "**Indoors Setup**".

Light Diffusers

When using the unit outdoors and the sky is very blue you need to use diffusers. Our diffusers are specially designed to carry out two functions.

- Evenly disperse intense light over the sensors.
- Collect light from surrounding objects.

On a cloudy or hazy day there is no need for diffusers. Diffusers can be used under any condition. It is recommended that they be used at all times in order to increase unit's performance. If the sun is shining directly into the optical slots, above the chronograph, then you should use diffusers.

Key Functions

The unit has 6 keys; some keys have multiple functions when held pressed. The display is a 4-Digits large LCD.



<u>Key Name</u>	<u>Key Function and Description</u>
<STATS>	Sets statistics mode, reviews stats
<DATA>	Sets Data mode, review shots
<MENU>	Displays Model number
<ENTER>	Displays lower digits
<UNITS>	Changes measurement units m-f
<POWER>	Turns the unit On or Off

All these keys have different functions when pressed in conjunction with other keys. Two, three or four key functions are intended for advanced users.

<DATA> Data Mode

When this key is pressed the unit switches to **Data Mode**. In this mode the unit remembers your last data position. Each time you press <DATA> key, it displays next shot. You can review your entire string by pressing this key.

When you press <DATA> key, the display will show your current data view position. For example, if last time you were reviewing shot number **03**, then this number will be displayed while you hold <DATA> key down. When you let go, then the actual velocity value will be displayed.

If you have just fired a shot, then this takes precedence over your last data pointer. For example if you have just fired a load number **8**, then the data view is forced to number **08**, irrespective of your last view position. For example you will see,



The two lower bars on each side indicate that you are in a **Chronograph** mode. This number is displayed as long as you hold down <DATA> key. When you release this key, then the velocity is displayed. For example, if your velocity was **386.87** the display will show,



If you want to view the remaining digits, which is **7**, you press and hold <ENTER> key. The remaining digits stay in view as long as you hold down <ENTER> key. For example in this case the display will show,

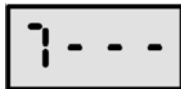

When you release the <ENTER> key, the display returns back to normal, i.e. **386.8**. We strongly recommend that you try CF-Mode because it scrolls data and stats like a spreadsheet.

<STATS> Stats Mode

When <STATS> key is pressed the unit switches to **Statistics Mode** and it will remember your last statistics position.

To use statistics you do not need a full string. Statistics can be used anytime as long as there is more than one shot in memory. Statistics are calculated in real time; therefore when in Stats Mode, you will see the results immediately on shot by shot basis as you shoot. Statistics display has no visible delay.

Statistics List

Each time you press <STATS> key the statistics scrolls forward. While the key is held pressed, the display shows stats identifier as listed below. When this key is released, then statistics calculation is displayed. Available statistics are listed below, in the order as they would appear,

Identifier

Statistics Description

.Lo.

Low value, Finds the lowest value

.Hi.

High value, Finds the highest value

.Av.

Average value, Calculates average value

.ES.

Extreme Spread, Calculates highest minus lowest

.Sd.

Standard Deviation, Calculates standard deviation

.Pd.

Percent STD, See **Percent Standard Deviation**

.To.

Total shots, Total number of shots in the string

When you press <STATS> key, current statistics identifier appears. For example if your last location was **Low Value** then the display will show



The two lower bars on each side indicate that you are in a Velocity mode. This identifier is displayed as long as you hold down **<STATS>** key. When you release this key, then actual lowest velocity is displayed.

For example, if your lowest velocity was **135.37**, then the display will show,



If you want to view the remaining low digits, in this case it is only **7**, then you press and hold down **<ENTER>** key.

In this example the display will show



Each time you press **<STATS>**, the statistics advance to the next position. When the end is reached it then loops back to the beginning. We strongly recommend that you switch to CF-Mode because it scrolls data like a spreadsheet. CF Mode can also do cross-string statistics; that is, you can compare stats between strings instantaneously.

Percent Standard Deviation (PSD)

Standard deviation is an incomplete representation of measured data behavior. In order to obtain a meaningful number you have to combine Standard Deviation with something else, such as the Average Value.

Here is an example of a typical problem. Let us assume that you fired two strings with 5 shots each at different velocity ranges. In the example below all values are in feet/sec,

Shot Number	String-1 1020-f/s Range	String-2 120-f/s Range
1	1010.00	110.00
2	1015.00	115.00
3	1020.00	120.00
4	1025.00	125.00
5	1030.00	130.00
Average Value	1020.00	120.00
Standards Deviation	7.9056	7.9056
Percent Deviation	0.7750	6.5880

As you can see from the results **String-1** and **String-2** have the same **Standard Deviation**, yet you know that shots in **String-2** are much worse. In order to solve this problem we have provided **Percent Standard Deviation**, which performs all the work for you and is defined as

$$\frac{(\text{Standard Deviation})}{(\text{Average Value})} \times (100)$$

This is a far **superior** performance indicator of your shots. According to our calculations **String-2** is far worse than **String-1** by a factor of

$$\frac{(6.5880)}{(0.7750)} = 8.500$$

Standard deviation (**STD**) alone would never reveal this problem because both strings would have the same **STD** number.

For those who insist on using Standard Deviation we still provide that value for compatibility with old chronographs.

<MENU> Model number & Menu

When <MENU> key is pressed display will show current mode and model number. For example if you are in **CE** mode and this is **CE-2** model then **CE-2** will be displayed as follows,

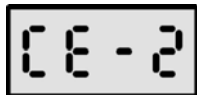

When the key is released, it returns back to the last display mode, which is either **DATA** or **STATS** view. This key brings up Menu when in **CF Mode**.

<ENTER> Lower digits view

This function displays the lower hidden extended digits. The unit displays results up to two decimal points. Whatever does not fit into a 4-digits display can be viewed with this function.

Extended Digits

The unit has 8-digits computation accuracy and it only displays the first most significant 4 digits. To see the remaining 4 digits you press and hold down the <ENTER> key. When you release this key, it returns back to normal display.

If there is no decimal point displayed, either on the normal view or when 4 lower digits are viewed, then this implies that the decimal point is at the end of normal view.

For example,
if the velocity is **1938.54**, then the display will show **1938**.
When <ENTER> key is pressed, then **54** will be displayed.
This implies that the decimal point is after number **1938**.

<UNITS> USA-Metric Conversion

This key switches from USA to METRIC units, and vice versa. It is always active so that you can use it to do on the fly unit's conversion check. USA units are feet/sec and METRIC units are meters/sec.

If you were using USA units, it will switch to METRIC units. If you were in METRIC units, it will switch to USA units.

Here is an example of how this is used. Let us assume that you just fired a shot and the number was **08** with velocity of **938.54** and you were using **USA** units.

The display will show



for about ½ seconds. The two lower bars on each side indicate that this is a velocity data mode. The absence of dots on each side of the number **08** indicates that you are in **USA** units.

Following ½ seconds delay the velocity value is displayed as follows,

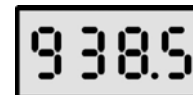

When you press and hold down <UNITS> key it switches to metric units. This is indicated by the following display,

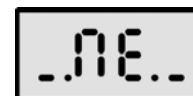

which indicates METERS mode. The two dots are METERS indicators and are also displayed with shot number and stats identifier.

When you release the key then the conversion value will be shown. In this case it will be **286.06** and the display will show

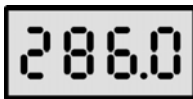

If you press the **<UNITS>** key again, the display will switch to **USA** units. In this case it will show **USA** units identifier as follows,



When you let go of the **<UNITS>** key then it returns back to showing the velocity in **USA** units, feet/sec,



You can switch back and forth without affecting the internal results or memory. You can either do a quick on the fly conversion check or you can return to your desired unit.

<POWER> Turn unit On-Off

This key turns the unit **On** if it was **Off**, and **Off**, if the unit was it **On**. To save power you should always turn the unit **OFF** while you are setting it up or is not being used. There is an auto power-off but it takes 30 minutes to kick in. **CF-Model** has user selectable Power-Off period that is set from 1 minute to about 4 hours, or none at all.

When the unit is Off and you press **<POWER>** key, the display will show **PUFF**, indicating that it is about to go to sleep and you can release the key now. If you subsequently touch **<POWER>** key, the unit wakes up again with the display showing **HELLO** greeting and then goes into Adaptive Calibration. You can continue with your work where you left it.

EXTENDED KEY FUNCTIONS

For advanced users we have provided extended functions. These are accessible when one or more keys are held pressed. If you find this method cumbersome, then you should consider switching to CF-Mode for a menu driven system.

If two keys have to be pressed, then you press and hold the first key and then press the second key while you still hold the first key pressed.

When three key have to be pressed then the first key is pressed and held down. The second key is pressed while the first is still held down. Finally you press the third key while the first two are held down. You cannot waver by letting go of first or second key, they all must be held pressed.

Delete shot <MENU+DATA>



This key combination clears current shot number from memory. The number that will be deleted is the one that shows up when **<DATA>** key is pressed. If you press **<DATA + MENU>** key sequence then you can watch displayed shot being deleted.

For example, to delete shot number **08** you press **<DATA>** key until **.08.** is displayed. While **.08.** is displayed you hold **<DATA>** key down and then press **<MENU>** key. The two bars on each side of the number will disappear and the display will show **08**, indicating that shot number **08** has been deleted.

If you change your mind then you can restore this deleted shot with **<MENU+ENTER+DATA>** key, as shown below. See **"Undo Delete Shot"**.

Clear memory <MENU+STATS >

When these two keys are pressed the entire memory is cleared. The old shots are not really lost they are simply moved into the trash bin. When these keys are pressed, display shows your string number and how many shots are in it.

CE-Mode uses a default string number **01**. For example, if your memory had **05** shots in it then the display would show . When all the keys are released, then the display show string **01** with nothing in it. For example, display shows , the dashes after the number indicate, the memory is empty.

If you changed your mind you can undo clear memory by pressing **<MENU+ENTER+STATS>** keys. See **“Undo Clear Memory”**.

Sensors Off <MENU+POWER>

This key combination turns off all environment monitoring sensors. When these keys are pressed display confirms your action by displaying , indicating that chronograph velocity capture is off.

This saves battery power and disables velocity measurement and turns **Off** all environment alarms. The power saved when sensors are off is about **50%**.

You can however perform all other functions except velocity measurements such as data review and stats review, etc.

In order to activate velocity measurement again, you must turn the unit **Off** and then **On**. This starts adaptive calibration and turns all the sensors on again.



Switch to CF mode <MENU+UNITS>

This key combination switches to **CF-Mode**. This is only possible if CF-Mode is enabled; see **“Enable CF-Mode”**. CF mode is an advanced operation with many features that go beyond **CE-Mode**, see **“CF-Model features”**.

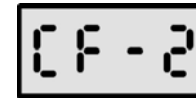
The unit will display the mode that is switching into. If you are in **CE-Mode** then it will switch into **CF-Mode**. In this case the display will show



In order to use the unit in this mode you may have to read the manual on **CF-2**.

You know that you are in **CF-Mode** when you press **<MENU>** key and the model number does not show up; instead the first menu header is displayed which is  in DATA menu and  in STATS menu. When you are in **CE-Mode** the model number  will be displayed instead.

Battery power level <ENTER+POWER>

This key combination displays battery power level in %-power remaining. For example if there is 43% of power left, then the display will show . When battery is new the power level is about **90%**; when power is low and battery needs changing, then the power level is **34%** or less.





The value is displayed only while you hold down both keys.

Muzzle Blast Control <ENTER+UNITS>

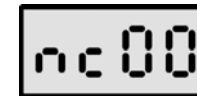
Every time these keys are pressed, muzzle blast sensitivity number is incremented by **10%**. When **98%** is reached then it loops back to **00%**. The range is from **00%** to **98%**.

As these keys are held pressed display will show muzzle blast sensitivity level. For example if sensitivity level is **00%** then display will show



You can only select one of 11 possible levels and they are as follows, from , , ...,  & . These correspond to 00%, 10%, 20%,..., 90% & 98% muzzle blast & noise reduction.

Muzzle blast reduction is hard to define because human hearing does not cover broad spectrum that will impact the unit. For example our chronograph will be affected by the frequencies from 1-Hz to 80,000-Hz. Muzzle blast contains a complex range of frequencies and the chronograph does not “hear” what you hear.

Please note that muzzle blast control will affect chronograph’s sensitivity when detecting projectiles. That is, as you increase muzzle blast & noise reduction you also decrease velocity detection sensitivity. Therefore we strongly recommend that you use muzzle blast reduction control as a last resort. This low cost unit, like most of the chronographs on the market, is based on PVC structure which does not resist muzzle blast very well.

Find Stats-Shot <DATA+STATS>

This key combination finds the location of the **Lowest value** or the **Highest value** in the string. Before using this function you must first locate **.Lo.** or the **.Hi.** with **<STATS>** key. This tells the unit which value you want to locate, the **Lowest** or the **Highest**. For example; if you want to locate the lowest value then stats key must display **.Lo.** When you press **<DATA+STATS>** then it jumps to the location in the string that contains the lowest value. The same process is used to find the highest value. This function is primarily intended for CF-Mode because it is a bit cumbersome in CE mode.

Please note that shot’s position is only displayed while you hold down both keys.

This function can be confusing if you subsequently press **<DATA>** key many times, because **<DATA>** key scrolls to the next shot position in the string. **CF-Mode** does not have this problem because it uses a uniform-menu driven interface.

Increment String <ENTER+STATS>

This function is only available from **Level 1, 2 & 3**. Before using it you must be in **Data** mode, if you are not sure then press and release **<DATA>** key.

When you press and hold **<ENTER>** key followed by pressing **<STATS>** key then your current string number and number of shots in it are displayed. For example; if your current string number was **01** with **5** shots in it then the display will show,



If the string is empty, display will then show **0 1:-** instead.

To move to the next string you hold down **<ENTER>** key and use **<STATS>** to increment string number.

Cross String Stats <STATS+ENTER>

This function is only available from **Level 1, 2 & 3**.

When you press and hold **<STATS>** key followed by pressing **<ENTER>** key then stats pointer and the string number is display as follows. For example, if the last stats viewed was **Low** value and the string number was **01** then the display will show,



This indicates that you are now viewing **Low** value for string number **01**. When **<ENTER>** key is released then actual low value is displayed, this works with all statistics.



NOTE

When **<ENTER>** key is pressed, while **<STATS>** key is down, for the first time current string is displayed. Subsequent pressing of **<ENTER>** key, while holding down **<STATS>** key, automatically increments string number by one.

For **Cross-String Statistics** comparison, hold down **<STATS>** key and use **<ENTER>** key to move from string to string. When **<ENTER>** key is released, while still holding **<STATS>** key down your string statistics are displayed. With this method you can check and compare your entire string set.

Undo Deleted Shot <MENU+ENTER+DATA>



This key combination reverses the deleted shot operation. When shot is deleted, it is moved into the trash bin. This function finds the old shot in the trash bin and puts it back.

When the first two keys are pressed an “undo” message is displayed as , and when the last key is pressed then  is displayed to confirm your operation.

CE-Mode permits only one delete-undelete at a time, whereas **CF-Mode** allows unlimited delete-undelete operations. What this implies is that you can only undelete your last deleted shot. For example if you deleted 3 shots one after the other then only the last one will be correctly restored. There is a way to get round this and that is, you either switch to **CF-Mode** or use **Data Recovery** function. Either of these methods requires some more reading.



Undo Cleared Memory <MENU+ENTER+STATS>

This key combination restores the effect of clearing the memory. When <MENU+STATS> keys are pressed, the memory is cleared and the contents are moved into the trash bin. This function restores old shots saved in the trash bin back to the memory.

When the first two keys are pressed an “undo” message is displayed as , and when the last key is pressed then  is displayed to confirm your operation.

Data Recovery <MENU+ENTER+POWER>

This command restores all the contents found in the trash bin back to the memory, irrespective of what it is. This is intended for emergency only; it is to be used if the battery went dead or the unit was accidentally reset and you want to recover old data. With this function all shots, which could be up to 40, are moved from trash bin back to the memory.

When the first two keys are pressed an “undo” message is displayed as , and when the last key is pressed, then  is displayed to confirm your operation.

To make sense of the recovered shots it may be necessary to delete unwanted shots one by one, with <MENU+DATA> key function. The shots are restored back to memory in a correct sequence. The only problem is that the system cannot differentiate between trash and good shots, so it restores everything.

Archery On-Off <ENTER+POWER+UNITS>

This key combination flips from normal mode to archery mode and vice-versa. This difficult key combination has been chosen on purpose to prevent accidental switch to-from archery mode.

For example, if the unit was in **normal mode** and this function is executed, then display would show,

The image shows a digital display with the text "Arc 1" in a monospaced font, enclosed in a rectangular border.

which indicates that the unit has flipped to **archery mode**.

Similarly, if the unit was in **archery mode** and this function is executed, then the display will show,

The image shows a digital display with the text "Arc 0" in a monospaced font, enclosed in a rectangular border.

which indicates that the unit is now in **normal mode**.

Whenever the mode is changed, the unit will turn on calibration alarms and bad environment alarms. Flashing **colon** and flashing **decimal** points indicate that you must calibrate the unit again.

Load Demo Shots <ENTER+POWER+DATA>

This key combination loads demo data into memory for the user to experiment with statistics and other functions.

To prevent accidental overwriting your working shots, the unit will refuse to load demo shots unless the memory is cleared.

CF-Mode has extensive control over demo shots range that you can load into memory

The unit confirms execution of this function by displaying .

Please note, once you load demo shots into the memory then entire trash bin is cleared. As a result you will not be able to recover any of the old shots by using “**Data Recovery**” function.



Reboot the unit <UNITS+MENU+DATA >

This key combination resets the unit. This is equivalent to removing the battery except that the data is not lost; it is simply moved into the trash bin before reset takes place.

If you have executed this command by mistake you can always restore your shots by executing “**Data Recovery**” function. For further details see “**Data Recovery**”.

This functions is the same for all our models which includes this model(**CE**) and all **CF** and **CH** models. This is similar to **Ctrl-Alt-Del** in PC world.

Memory Alarms MENU+ENTER+UNITS+STATS>

When these keys are pressed in sequence shown, memory alarms are enabled or disabled. If the alarms were **Disabled** then they are **Enabled**, and vice versa. Display shows  if they are Enabled and  if they are disabled. See “**Errors & Alarms**”.

Access Control <MENU+ENTER+UNITS+DATA>

CF-Mode is enabled by pressing four keys in the following sequence **<MENU+ENTER+UNITS+DATA>**, when  appears you then release all keys. A 6-key password must be entered.

The number after the bars indicates your current access level, which can be 0 to 3. To activate **CF-mode** you must chose **Level-2** or **3** password. **Level-1** is the default mode and it prevents **CE-mode** entering **CF-mode** and **CF-mode** entering **CE-mode**.

Level



Password keys

0	<UNITS>,<UNITS>,<UNITS>,<UNITS>,<UNITS>,<UNITS>
1	<POWER>,<POWER>,<POWER>,<POWER>,<POWER>
2	<POWER>,<UNITS>,<ENTER>,<MENU>,<DATA>,<STATS>
3	<STATS>,<DATA>,<MENU>,<ENTER>,<UNITS>,<POWER>

These are single keys, pressed in sequence, and only 1-Second per key is allowed. If entry is slow or wrong password entered, then no change takes place. **CF-mode** is a menu driven system, see CF Manual. Flipping between modes with **<MENU + UNITS>** keys does not affect any setup.

Note: When you select **Level-0** the unit operates in **CE-1** mode, where only current string is accessible. Other levels have access to multiple strings. CE is set to 4 strings with 10 shots each.

Power-Up Features

Clear Memory. When **<ENTER>** key is held pressed prior to turning the unit on with **<POWER>** key, then the memory is cleared. If you are successful, display will show  message, indicating that the memory was cleared. If you are not successful then  message is displayed. Model **CE-1** clears the memory on power up automatically; therefore this has no effect on **CE-1**.

Shot Increment Mode. When **<MENU>** key is held pressed prior to turning on the unit with **<POWER>** key, shot increment mode is changed. If it was in **Linear** mode it will be set to **Circular** mode and visa versa. Circular mode means that the shots loop around to number **01** when the string end is reached. Linear mode means the shots are shifted back towards **01**. No matter what mode is used only the oldest shots are lost.

Archery Mode Notes

<ENTER+POWER+UNITS>

Archery mode is intended to be used for quiet firearms, that is, devices that are not very noisy. Archery mode does not affect high velocity projectile measurement at all. The only problem is that high velocity firearms are loud and the noise may cause false triggering.

For loud shooting devices the chronograph has to be placed way back from the source of the noise. The chronograph may be placed 10-feet from the firearm to start with. The user must move the unit further back if muzzle blast causes false readings or errors. This low-cost-unit has a limited capability for detecting muzzle blast.

Supersonic Firearms

Firearms with supersonic speeds do not affect archery mode. The projectile reaches the chronograph before the sound wave does, therefore it does not effect velocity measurements.

Indoors & Interference

Our “**True Archery mode**” works well in outdoors only. Nearby power lines, fluorescent lights, and other artificial lights sources may affect archery mode. That is why we do not recommend it for indoor use.

The unit will detect indoor environment by analyzing power line interference and other man made interference sources. Once this interference is detected, it will calculate the effect it may have on the velocity measurements. If the effect is significant then it will refuse to accept shots and a flashing colon-alarm will appear. Even if you attempt to fool it by taking it outdoors, calibrating it and then slowly bringing it indoors, it will still detect your attempt.

It is possible to use archery mode indoors if the power lines and electric appliances are at least 40 feet away and are properly shielded and there are no artificial sources of light in sight.

High Detection Capability

Another problem is that archery mode will detect arrows and paintballs as high as 8-feet when the light conditions are good. This may be deceiving because this chronograph is only guarantied to meet the accuracy specified at 6-inches above the optical slots. It is quite possible that your unit may be just as accurate above 4-feet, however we do not test for such capability. This is a low cost unit and it is only meant to function up to 12” above the optical slots. In the future we will provide precision units that will be accurate at ++24”.

Our Archery vs Theirs

In indoors or outdoors environment our unit, even in normal mode, outperforms competing archery-chronographs anytime. Here is a simple test to verify this fact.

Set our unit to normal mode (not archery mode) and take both units indoors or outdoors and drag your hand over the sky-screen at about 2.5-feet/sec. You will see that only our unit will detect your hand with such low velocity. This is only possible because of our innovative design that uses Adaptive Calibration.

The competing chronographs physically change electronic components on their units to achieve a quasi archery mode. We, on the other hand, use digital control to achieve a true archery mode that can measure velocities down to **2.5 f/s**.

One of our units is equivalent to two of the competing units. When you need a true archery, it is available by simply pressing a few keys. In **CF-Mode** you simply select it from a menu.

Error Messages

The unit uses a multitasking operating system and it continuously monitors all important parameters, such as light conditions, battery status, missed shots etc, while you are shooting. When something goes wrong, it reports the error by flashing a message on the display. Bellow are some of the possible messages that may be displayed. Urgent or Serious messages have to be

acknowledged by pressing **<ENTER>** key. Not so serious one will flash for a while and then disappear.

Calibration Failure

When calibration fails because operator terminated the process or the conditions are bad, then all decimal points on the LCD will start to flash.

To remedy this you must try again by turning the unit off and on again. If this does not work, then you must read the section on **<Calibrating the Unit>**. You may have to remove the source of problem or provide sufficient light.

Setup Failure

Every time you fire a shot, the unit takes about 0.3 seconds to test and verify that there are no environment problems. If severe changes have been detected that will degrade performance, then the colon starts to flash. The unit will refuse to take more shots until you recalibrate it and correct the problem. The only way to fix this is to run calibration again by turning the unit off and on. The unit will now perform a thorough test to verify that you can still use the unit with considerable reliability.

Battery

Battery level is continuously monitored and the following errors are displayed, indicating Power Errors. The message is displayed once only, it is only redisplayed again if the conditions changed.

 Power level has dropped below 5.3 Volts. The unit will not be able to calibrate. The battery is considered DEAD. You can only use it for Data and Stats retrieval. You must replace the battery here.

 Power level has dropped below 6.0 Volts. The unit may still function but the results will not be accurate. You should only use the unit for Data retrieval and Stats review. You should change the battery.

 Power level has dropped below 7.0 Volts. The unit's performance will start to degrade. You should consider replacing the battery.

Please note that data retrieval and review section still functions with crisp clear display, even when the battery is considered dead. However we recommend that you do not push your luck because below 3.95 volts you will begin to lose you data.

Velocity Capture



The unit will attempt to differentiate between real shot and muzzle blast or external interference. Because this is a low cost unit, detection of muzzle blast and external interference is not always 100% effective. Therefore here we have provided a limited alarms that indicate when a shot has been misread,

 Front sensor was missed

 Middle sensor was missed

 Rear sensor missed

 External interference or muzzle blast detected



 These represent external interference or sensor obstruction. In this particular model, which has only two sensors, these errors are not well defined.

Memory Overflow

The unit will attempt to differentiate between real shot and muzzle blast or external interference. Because this is a low cost unit, detection of muzzle blast and external interference is not always 100% effective. Therefore here we have provided a limited alarms that indicate when a shot has been misread,

Err 0 There is no more room in the string for more shots.

Err 1 There is room in the string for one more shot.

Operator

Operator entries are monitored and when an invalid operation is performed you will get one of the following messages,

Err 1 Undelete shot not possible because there are no deleted shots in trash bin.

Err 2 An attempt has been made to load demo shots into memory that is not empty This is a safety measure that prevents the user accidentally overwriting good working data.

Err 3 The unit has many levels of difficulty. If you attempt to execute a higher level function than your current access permits, this error comes on. This is a common error when operating in **CF-Mode**.

Err 8 This indicates a general access violation. This is not a bug but it may indicate that you have discovered one of factory-test-functions.

Troubleshooting

Dead Unit

If nothing happens when you replace the battery, you check the following. Measure the battery voltage. Make sure the battery is installed correctly and not reversed.

To make sure the unit boots up properly when you have problems, you press and hold down the **<POWER>** key for 30 seconds. You do this with the battery removed.

The battery voltage must be at least 4.6 Volts. The unit will not function as a chronograph with such a low battery, it may only be used for data retrieval and stats review.

The battery may measure way over 4.6 volts on the voltmeter when measured without a load. When installed, the load may bring the voltage below 4.6 volts. A typical characteristic is a quick black display which suddenly disappears.

It must be noted that the chronograph will not detect velocities properly if the battery voltage is below 7.00 volts, under load. The unit will begin flashing power level alarms

Flashing Decimal Point

If all **decimal points** are flashing, this means that the unit will not detect velocities unless it is calibrated again. The calibration is done by turning the unit **off** and **on** again. If you want to use the unit just for data retrieval and stats review, then you should turn **off** sensors by pressing

<MENU + POWER> key

Flashing Colon

When **colon** is flashing this means that the environment is not suitable for velocity measurements. You must recalibrate the unit. If sensors have been turned off, flashing colon will stop after you begin stats or shots review.

The unit will however remind you every 60 seconds that it needs to be calibrated again. The reminder will be flashing colon which can be suppressed for another 60 seconds by a simply executing stats or data review.

Unit will not Calibrate

All dots are flashing, indicating that the unit failed to calibrate. There are three possible conditions,

- **Battery is dead**; the voltage is below 7.0 volts, under load.
Check battery power level with **<ANTER+POWER>** keys.
It should be greater then 34%.
- **Indoors.**
Fluorescent or sodium lamps are nearby, reflecting off the ceiling and walls.
Artificial lights may be too strong and are shining directly into the optical slots, try using diffusers..
There may not be enough light, must provide some light.
The unit is in Archery mode. Archery mode does not work well in indoors, see “**Archery On-Off**” and “**Archery Notes**”
- **Outdoors.**
If you have Archery mode **On** try swathing it **Off**, see “**Archery On-Off**” function.

Sky is very blue and you are in Archery Mode. Under very deep blue sky, archery mode may not be able to calibrate.

When in archery mode, moving tree branches above the chronograph will be interpreted as an unstable environment.

CE-Mode features

CE series are next generation intelligent chronographs that provide unique new features with a simple user interface. There is one key for each simple function. We do not have complicated key sequences that are found in some chronographs. Most of the basic functions and statistics are accessible with a single key operation. CE-2 model has one folder and one ram disk only.

Here are some of the highlights for **CE** models,

- Housings are temperature matched using a single large die.
- Digitally compensated temperature expansion, +/-0.001 inch.
- Ambient temperature is recorded, internally, with every shot.
- Sensors are precision mounted with a proprietary process.
- It has a 40-shot memory.
- Memory string can be cleared or un-cleared.
- Individual shots can be deleted or un-deleted.
- Data recovery for accidental reset.
- Shots may be reviewed one by one, separate from Stats.
- Move from string to string in data mode.
- Statistics may be review one by one, separate from Shots.
- Real time statistics permits Stats view as you shoot.
- Cross String Statistics, compare stats from string to string.
- Stats provided are; Low, High, Average, Extreme Spread, Standard deviation, Percent Standard Deviation and Total Number of shots in the string.
- Uses Adaptive Calibration for environment testing.
- Remembers shots, even when turned off.
- Auto power shut-off after 30 minutes of inactivity.
- Battery Power level meter, displayed in % power left.
- Extensive alarm and error messages.
- Digitally selectable muzzle blast reduction from 00% to 90%
- True archery mode that is digitally selectable.

Our unit has digitally selectable “**true archery**” mode, the very first such device on the market. You can switch from normal mode to archery mode, and vice versa, by simply pressing a few keys. Competing chronographs must change electronic parts to produce a quasi archery mode with severe limitation. One of our units replaces two of theirs; our range is from **2.00** to **9999.99** f/s.

CF-Mode features

This mode has over 50 functions available to the user. There are 3 Levels of difficulty that are set by user passwords.

CF-Mode has all the functions of **CE** mode plus more. Instead of using multiple keys, it uses a menu driven system. Here is a summary of all the main features. **CF Mode** is much friendlier to use if you take time to read CF manual (a draft copy will be posted on our website after Aug/20/2003 on).

- It has 40 shot memory
- Memory can be divided into 1 to 10 strings
- Shots are stored in strings
- Strings are stored in folders.
- Folders are stored in Disk drives
- Delete & Undo Deleted shot
- Clear & Undo Cleared string
- Delete Folder & Undo Deleted folder
- Data recovery from trash bin
- Format Disk Drive
- Check free disk space
- Each shot has temperature stored with it
- Velocity and temperature are synchronized at all times
- Scroll shots/temperature data forward and backward
- Scroll shots/temperature statistics forward or backward
- Data & Stats scroll locations are independent of each other
- String to string scroll in Data or Stats mode.
- String to String stats comparison
- View Statistics in real time as you shoot
- Change measurement units on the fly, Metric-USA
- User selectable alarms and warnings
- User selectable power down time, 1-min to 4-hours, or none
- Real time temperature display in Celsius or Fahrenheit
- Real time battery voltage display
- USA or METRIC system select, smart units conversion.
- Demo shots control, velocity range and string size.
- Stats with Energy and Power factor
- Bullet mass entry, from 0.1 to 819.2 grains
- Unique 12-digit serial number display
- User selectable sensitivity level control
- For further details get **CF-Manual** from www.chronotar.com
- End...

Specifications

Computational Range	1.00 to 80,000.00	Feet/Sec
Applications Range	2.00 to 9,999.00	Feet/Sec
Accuracy, Low speed 6.0" above the sensors 2.5 f/s to 999 f/s	0.3	%
Accuracy, High speed 6.0" above the sensors 999 f/s to 10,000 f/s	0.5	%
Clocking Frequency	24,000,000	Hz
Shooting Area Low speed range, 2.5 f/s to 999 f/s	60	Inches Square
Shooting Area High speed range, 1000 f/s to 10,000 f/s	20	Inches Square
Operating Temperature Battery > 7.0 Volts	- 20 to + 70	Degrees Celsius
Operating Temperature Battery > 7.0 Volts	- 4 to + 158	Degrees Fahrenheit

Warranty

This product is warranted against all manufacturing defects for the period of 5-years. If the product is found to be defective please return it directly to us for repair or replacement.

Index

Access Control.....	43	Lower digits.....	33
adaptive calibration	18	Memory Alarms	43
Archery Mode Notes	45	Memory Overflow.....	48
Archery On-Off	42	Model number	33
Battery.....	47	moving shadows.....	25
Battery power level	38	Muzzle Blast	22
Battery voltage	12	Muzzle Blast Control.....	38
beyond 10,000 f/s	23	next generation	52
Calibration Failure.....	47	Operator.....	49
CF-Model features	53	Outdoor Calibration	19
Clear memory	36	Outdoors Setup.....	16
Clear Memory	44	Password keys.....	44
Cross String Stats.....	40	Percent STD	31
Data mode.....	29	Power-Up Features	44
Data Recovery	41	Quick Reference.....	6
Dead Unit	50	Quick setup	15
Delete shot.....	36	Quick start	12
detect muzzle blast	22	Reboot the unit.....	43
Errors	46	Returning the unit.....	56
Extended Digits.....	33	Run Calibration	18
EXTENDED FUNCTIONS	36	Sensors Off	37
Find Stats-Shot.....	39	Setup Failure	47
First Time User	25	Specifications.....	54
Flashing Colon	51	Statistics Description	30
Flashing Decimal Point..	50	Statistics List	30
Fluorescent lights	26	Stats Mode.....	30
Functions Overview	52	String Stats-Compare	40
Getting Started	24	Supersonic Firearms	45
high intensity LED's.....	17	Switch to CF mode.....	37
High readings	23	Table of contents	3
highlights	52	Technical support.....	56
How chrono works	25	Troubleshooting.....	50
Incandescent lights.....	26	Turn unit On/Off	35
Increment Mode.....	44	Turning the unit on	13
Increment String.....	40	Undo Cleared Memory	41
Indoors Calibration	19	Undo Deleted Shot.....	41
Indoors Setup	15	Unit will not Calibrate	51
Key Functions	28	Units select f-m	34
LED Array	17	Velocity Capture.....	48
Light Diffusers.....	27	Verifying Operation.....	13
Load Demo Shots.....	43	Warranty	54

CHRONOTAR.COM

Address

Chronotar Micro

936 Monte Carlo Court, Suite #4
Mississauga, Ontario,
Canada, L5C-3M1

Telephone 905 803-8719

Fax 905 803-8719

E-mail

ce@chronotar.com

or

servulo@chronotar.com

Returning the unit

Before returning the unit, you must give us a call to obtain return Instructions or visit our website and click on Returns menu. You can also contact us via email at return@chronotar.com.

Technical support

If you have any problem with the unit, even a minor one, please let us know. You can either, call us, email a note to help@chronotar.com, or contact us directly via our website. Just click on Contact Us menu.

Main Website

<http://www.chronotar.com>

©Copyright Chronotar Micro, 2002,2003